



By the Bloom

Size: 60" x 60"

From the In Bloom Collection by FreeSpirit.
Quilt designed and made by Marsha Evans Moore.

Requirements:

- 3/4 yard D923-151, D928-151 (binding), D926-410, D927-458, D928-458
- 1 3/4 yards D924-410, D926-505
- 1/4 yard D923-458, D927-410, D926-505, D928-240, D929-305, D926-151, D929-145
- 1 yard D928-458
- 1/2 yard D929-410, D926-506
- 3 1/2 yards backing D925-305
- 65" square quilt batting
- Template plastic

Cutting and Piecing Center Star:

1. Make diamond templates from template plastic. 'C' is the center diamond and 'B' is the border diamond. Cut diamonds: 8 'C' and 24 'B' from D923-458; 16 'C' and 16 'B' from D927-410; 24 'C' from D926-505; 32 'C' from D928-458; 24 'B' from D927-458; 21 'C' from D929-305; 16 'B' from D929-145; 16 'C' and 16 'B' from D928-240. Set 'B' diamonds aside
2. Arrange the center diamonds as shown in the diagram. Stitch the diamonds together to make four rows of four diamonds each. Press seam allowance in rows 1 and 3 up and in rows 2 and 4 down. Stitch rows together matching seams to make a star point.

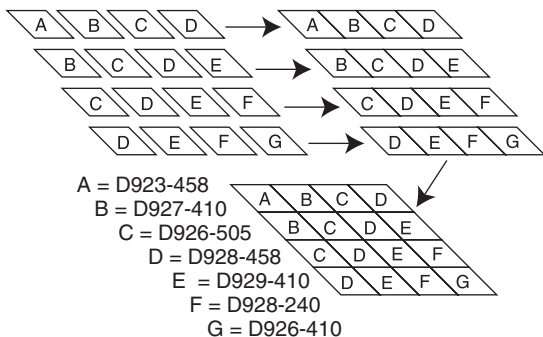

Make eight star points.

Stitch star points together into pairs, starting and stopping stitching 1/4" from edge. Make 4 pairs.

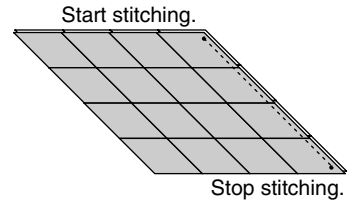

3. From D923-151, cut four squares 8 1/2" x 8 1/2". Set in squares between the star points as shown. Start and stop stitching 1/4" from edge. Pull square over and stitch other side.

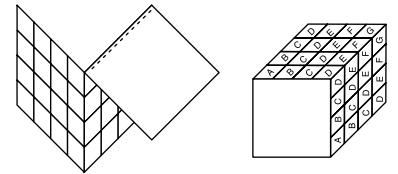

Stitch two diamond/square units together. Complete 2 units.

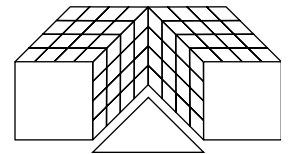

From D923-151, cut one square 12 1/2" x 12 1/2".

Cut square diagonally into four triangles. Set in triangle between star points. Start and stop stitching 1/4" from edge. Stitch halves together. Then set in the final 2 triangles. Square center to 28 1/4".

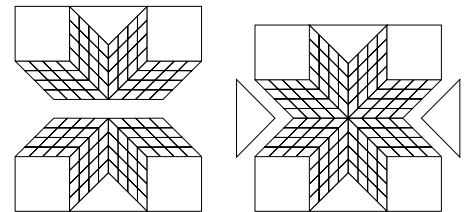

4. From D927-458, cut 4 strips 4 3/4" x 40" centered over the stripe. Mark the border strips as shown for the exact measurement of the quilt center (28 1/4 x 28 1/4"). Fold strips in half to find center. Pin strips to quilt center. Stitch strips to center, stopping and starting stitching 1/4" from edges. Repeat for remaining two strips

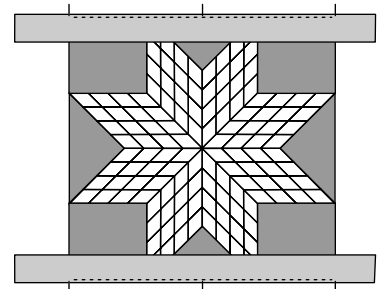

Fold quilt in half diagonally and stitch borders at a 45° angle.

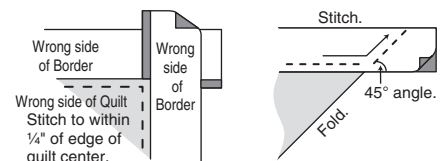

- From D926-151, cut 2 strips $1\frac{1}{2}$ " x $36\frac{3}{4}$ ". Stitch to sides of quilt center. Cut 2 strips $1\frac{1}{2}$ " x $38\frac{3}{4}$ ". Stitch to top and bottom of quilt center.

Cutting and Piecing Star Border:

- From each D926-410 and D929-410, cut forty border diamond squares and 40 border diamond triangles.

Arrange 'B' diamonds cut in step 1 into groups of 8 to make star blocks for the borders.

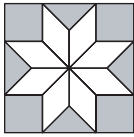

Alternate stars with D926-410 and D929-410. Make 20 stars following set-in piecing instructions for center star.

- From D928-458, cut forty border diamond short strips. Stitch to opposite sides of diamond star blocks. Cut forty border diamond long strips and stitch to opposite sides of diamond star blocks.

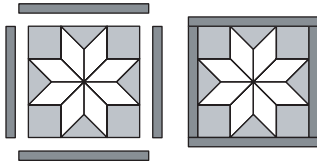

- From D926-505, cut thirty-two border side triangles and twelve border corner triangles.
- Stitch side and corner triangles to diamond stars as indicated in the diagram.

Side Borders.

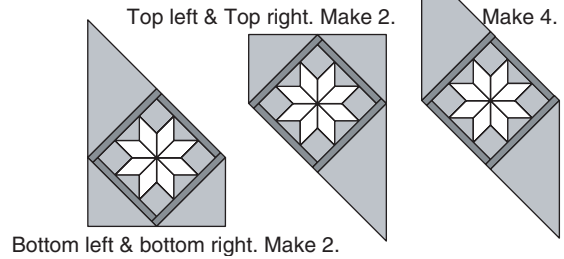

Top and Bottom Borders.

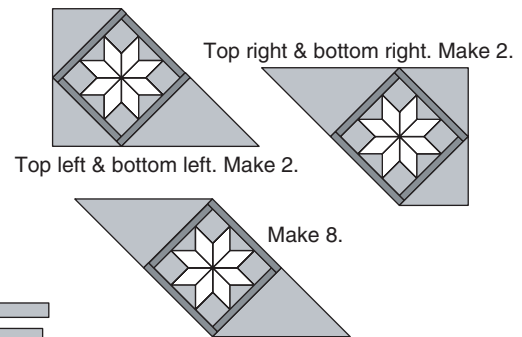

- Following diagram to the left, stitch side border units together, then stitch border strips to the sides of the quilt center.

- Stitch top and bottom border units together, then stitch border strips to the top and bottom of the quilt center.

- From D926-506, cut 4 strips $1\frac{1}{2}$ " x width of fabric centered over the stripe. Recut and piece along short end to make 2 strips $1\frac{1}{2}$ " x 56". Stitch to sides of quilt center. These strips will be slightly longer, so you will need to trim the excess.

Cut 4 strips $1\frac{1}{2}$ " x width of fabric centered over the stripe. Recut and piece along short end to make 2 strips $1\frac{1}{2}$ " x 60". Stitch to top and bottom of quilt center. Again, these strips will be slightly longer, so trim the excess.

- Layer, quilt and bind. Cut binding strips $2\frac{1}{2}$ " wide.

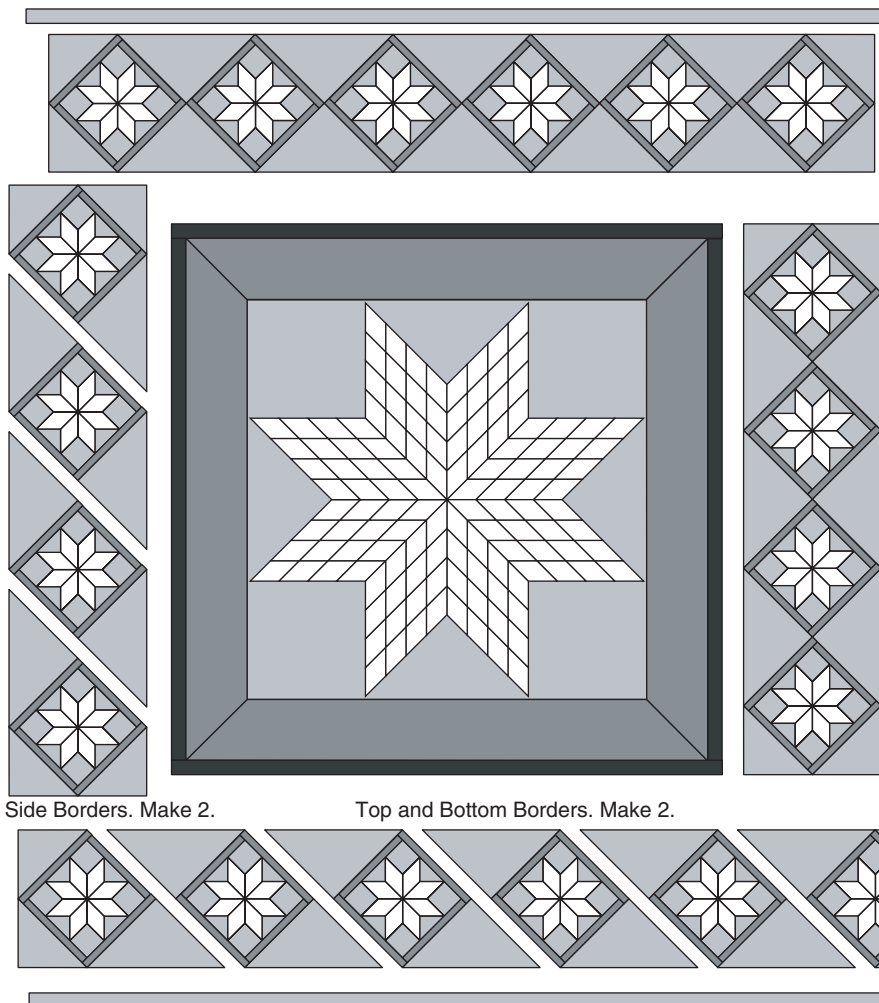

Note: This quilt differs slightly from the photo. Directions for quilt have been altered from original quilt for ease of construction.



1350 Broadway, 21st Floor, New York, NY 10018
Please visit www.freespiritfabric.com to download this and other patterns.

